



NovoSoft 465 Series Water Softener Operation Manual

Note:

1. Read all instructions carefully before operation.
2. Avoid pinched o-rings during installation by applying (provided with install kit) NSF certified lubricant to all seals.
3. Unit is factory set for "Clean Water" application.
See factory settings for "Problem Water" on page 10.

TABLE OF CONTENTS

System Specifications.....	3
How Your Water Conditioner Works.....	3
Main Valve Functions.....	4
General Installation.....	5
Start-up Instructions	6
Level I User Programming	6
Level II User Programming	8
System Configuration.....	10
Maintenance.....	11
Valve Drive Assembly Exploded View.....	13
Control Valve Assembly Exploded View	14
Troubleshooting.....	15
Guarantee.....	16

System Specifications

Model	System Capacity Grains			Flow Rate		Regeneration Water Usage (Gallons)		Mineral Tank Size	Resin Cu. Ft.	Brine Tank / Cabinet Size Inches	Salt Capacity (Lbs)	Ship Weight (Lbs)
	@ 10 lbs/cu ft	@ 6 lbs/cu ft (Factory Setting)	@ 3 lbs/cu ft	Service USGPM	Backwash USGPM	Clean Water (Factory Setting)	Problem Water					
NVO465-75	21,000	18,750	11,550	8.0	1.5	29.5	37.0	8 x 44	0.75	15.8 x 32.1	250	84
NVO465-100	28,000	25,000	15,400	10.0	2.0	38.0	48.0	9 x 48	1.00	18.1 x 34.5	300	104
NVO465-150	42,000	37,500	23,100	12.0	2.4	48.5	60.5	10 x 54	1.50	18.1 x 34.5	300	133
NVO465-200	56,000	50,000	30,800	15.0	3.0	80.5	95.5	12 x 52	2.00	20.3 x 37.4	400	153
NVO465-300	84,000	75,000	46,200	15.0	5.0	106.5	126.5	14 x 65	3.00	20.3 x 37.4	400	220
NVO465-75C	21,000	18,750	11,550	8.0	2.0	29.5	37.0	9 x 35	0.75	16.5x19.3x43.3	300	84
NVO465-100C	28,000	25,000	15,400	10.0	2.4	38.0	48.0	10 x 35	1.00	16.5x19.3x43.3	300	104

Figure 1. Specifications

- C indicates cabinet Models
- Maximum Water Temperature = 110°F (43°C)
- Maximum Operating Pressure = 100 PSIG (689 kPa)
- Voltage = 110 volts standard
- Units are factory set for “Clean Water” applications. For installations with problem water (Iron, Manganese, turbidity, etc.) please refer to Figure 12 on page 10 for “Problem Water” valve settings.
- At the stated service flow rates, the pressure drop through these devices will not exceed 15 psig.
- The manufacturer reserves the right to make product improvements which may deviate from the specifications and descriptions stated herein, without obligation to change previously manufactured products or to note the change.

How Your Water Conditioner Works

The principle behind water softening is simple chemistry. A water softener contains resin beads which hold electrically charged ions. When hard water passes through the softener, calcium and magnesium ions are attracted to the charged resin beads. It's the resulting removal of calcium and magnesium ions that produces soft water.

This valve is controlled with simple, user-friendly electronics displayed on a large LCD screen. The main page displays the current date and time. In addition, the main page also shows key valve information and statistics including; current capacity setting, volume remaining, date of last regeneration, current flow rate, and peak flow rate.

MAY 8, 2009 9:05 AM	CAPACITY 1,350 GAL	VOLUME REMAINING 1,125 GAL
REGEN DAYS 7 DAYS	REMAINING DAYS 5 DAYS	REGENERATION TIME 2:00 AM
LAST REGEN MAY 4, 2009	CURRENT FLOW 1.5 GPM	PEAK FLOW 5.8 GPM

Figure 2. Main Page Displays

NOTE: REGEN DAYS and REMAINING DAYS are only shown in the CALENDAR CLOCK mode or METER OVERRIDE mode.

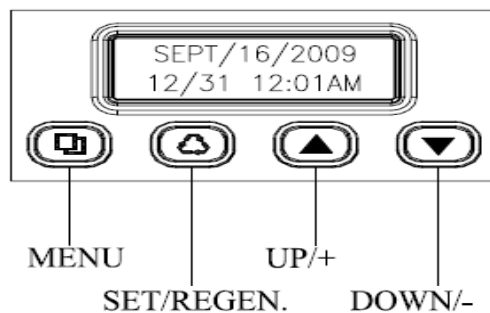

Figure 3. Key Pad Configuration

- MENU BUTTON “☰”:** The function of this key is to enter the level one programming mode where the valve settings can be adjusted.
- SET / REGEN BUTTON “↻”:** This button has two functions. The first is to initiate a manual regeneration by holding the button for 3 or more seconds. The second function is while in programming mode, pressing this key allows the user to change the value of each setting.
- UP / DOWN “▲▼”:** These buttons are used to increase or decrease the value of the settings while in the programming mode.

System Initialization

When power is first supplied, the valve may take up to two minutes to initialize the valve. During this time the valve will show “INITIALIZING WAIT PLEASE”. Do not touch any buttons at this time. When the valve reaches the service position, it will display the current date and time.

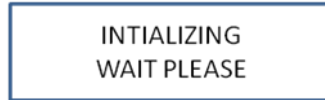

Figure 4. System Initialization Display

Main Valve Functions

Regeneration Mode: 1. METER DELAYED 2. METER IMMEDIATE 3. CALENDAR CLOCK 4. METER OVERRIDE

Capacity Calculation: 1. AUTOMATIC 2. MANUAL

Adjustable Cycles: All of the valve cycles are fully adjustable.
 1. BACKWASH 2. BRINE / RINSE 3. RINSE 4. REFILL

NOTE: Refer to Level Two User Programming for description of each mode.

During a regeneration cycle, the valve will display what position it is advancing to. Once in the correct position, the valve will display the current position along with the time remaining for that cycle. On the bottom row, the time remaining is also graphically displayed.



Figure 5. Regeneration Cycle Valve Display

Manual Regeneration

Press “↻ SET/REGEN” for three seconds to initiate a manual regeneration. When the valve reaches any cycle position, pressing any key will automatically advance the valve to the next position.

Control Operation During A Power Failure

In the event of a power failure, the valve will keep track of the time and day for 48 hours. The programmed settings are stored in a non-volatile memory and will not be lost during a power failure. If power fails while the unit is in regeneration, the valve will finish regeneration from the point it is at once power is restored. However, since the unit did not complete its regeneration, it will queue another regeneration at the next scheduled regeneration time.

If the valve misses a scheduled regeneration due to a power failure, it will queue a regeneration at the next regeneration time once power is restored.

General Installation

Water Pressure	Minimum 25 PSI
Electrical Supply	Uninterrupted AC
Existing Plumbing	Free of any deposits or build-ups inside pipes.
Unit Location	Locate close to drain and connect according to plumbing codes
Bypass Valves	Always provide for bypass valve if unit is not equipped with one.
Plumbing	Softener and other water treatment equipment should be installed to local plumbing codes

	CAUTION <ul style="list-style-type: none">▪ Do not exceed 120 psi water pressure.▪ Do not exceed 110°F water temperature.▪ Do not subject unit to freezing conditions.
---	---

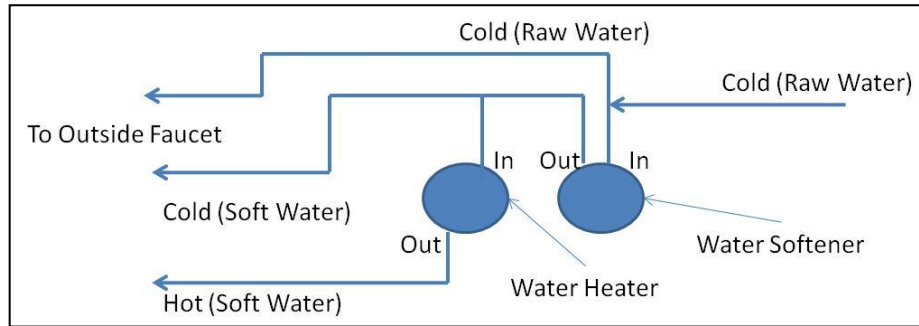

Figure 6. Piping Diagram

1. Locate the softener tank and brine tank close to a drain where the system will be installed. The surface should be clean and level.
2. Perform all plumbing according to local plumbing codes.
 - Use a ½" minimum pipe or tubing size for the drain line
 - Use a ¾" pipe or tubing for backwash flow rates that exceed 7 gpm or length that exceeds 20ft (6 m)
3. Any solder joints near the valve must be done before connecting any piping to the valve. Always leave at least 6" (152 mm) between the valve and joints when soldering pipes that are connected to the valve. Failure to do this could cause damage to the valve.
4. If the valve is not installed on the tank, cut the 1" central pipe flush with top of each tank. Lubricate the large o-ring on the valve that seals against the tank. Screw the valve on to the tank. Be careful to not cross thread the valve into the tank. Only use silicone lubricant.
5. Connect the drain line to the valve.
6. Connect the brine line from the brine tank to the valve.
7. Add water until there is approximately 1" (25 mm) of water above the grid plate. If the tank does not have a grid, add water until it is above the air check in the brine tank. Do not add salt to the brine tank at this time.
8. Place the unit in the bypass position.
9. Slowly turn on the main water supply.
10. At the nearest cold treated water tap nearby remove the faucet screen, open the faucet and let water run a few minutes or until the system is free of any air or foreign material resulting from the plumbing work. Close the water tap when water runs clean, then proceed to start up instructions.

Start-Up Instructions

1. Plug the valve into an approved power source.
2. When power is supplied to the control, the screen will display "INITIALIZING WAIT PLEASE" while it finds the service position.
3. Press "⏪ SET/REGEN" and hold for 3 seconds to initiate a manual regeneration and advance the valve to the Backwash position. Open the inlet on the bypass valve slowly and allow water to enter the unit. Allow all air to escape from the unit before turning the water on fully then allow water to run to drain for 3-4 minutes or until all media fines are washed out of the softener.
4. Press any button to advance to the BRINE position. Check the water level in the brine tank to insure the valve is drawing brine properly.
5. Press any button to advance to the RINSE position. Check the drain line flow. Allow the water to run for 3-4 minutes or until the water is clear.
6. Press any button to advance to the REFILL position. Check that the valve is filling water into the brine tank. Allow the valve to refill for the correct amount of time as displayed on the screen to insure a proper brine solution for the next regeneration.
7. Press any button to advance to the SERVICE position. Open the outlet valve on the bypass, then open the nearest treated water faucet and allow the water to run until clear, close the tap and replace the faucet screen.
8. Add salt into the brine tank.
9. Program hardness and people into controller using Level One Programming Instructions.

Level I User Programming

Setting Current Time

1. Press "⏪ MENU" for 3 seconds to unlock screen. Press "⏪ MENU" again to enter level one programming mode and adjust CURRENT TIME.
2. Press "⏪ SET/REGEN" to adjust hours. When you have entered the change value mode, the cursor will blink. Press "▲ or ▼ UP OR DOWN" arrows to change the hour values. Press "⏪ SET/REGEN" again to accept the hour value and advance to change the minutes value. Press "▲ or ▼ UP OR DOWN" arrows to change the minute values. Press "⏪ SET/REGEN" again to accept the minute values and advance to adjust the AM/PM values. Press "▲ or ▼ UP OR DOWN" to change the AM/PM value. Press "⏪ SET/REGEN" again to accept the AM/PM value and exit. When you have exited the change value mode, the cursor will stop flashing.

Setting Current Date

1. Press "▼ DOWN" to advance to CURRENT DATE.
2. Using the same procedure as setting the time, press "⏪ SET/REGEN" to enter value change mode.

Setting Number of People

1. Press "▼ DOWN" to advance to NUMBER OF PEOPLE.
2. Press the "⏪ SET/REGEN" to change the value. Press up or down arrows to change the values.

Setting Water Hardness

1. Press "▼ DOWN" to advance to WATER HARDNESS.
2. Press the "⏪ SET/REGEN" to change the value. Press "▲ or ▼ UP OR DOWN" to change the values.

Setting Vacation Mode

1. Press “▼ DOWN” to advance to VACATION MODE.
2. Press the “♻️ SET/REGEN” to change the value. Press “▲ or ▼ UP OR DOWN” to change the values.

Exiting Level One User Program Mode

At any time, press the “☰ MENU” to accept all changes and return to main page display.

Level I User Program Mode		
PARAMETER	OPTIONS	DESCRIPTION
1	CURRENT TIME	This option is the current time of day.
2	CURRENT DATE	This option is the current date. The date is used to track the last time the system regenerated.
3	NUMBER PEOPLE	This value is the number of people living in the home. It is used to calculate the amount of water needed for daily use and the reserve capacity of the system.
4	WATER HARDNESS	This value is the maximum water hardness in grains per gallon of the raw water supply. It is used to calculate the system capacity.
5	VACATION MODE	This function may be activated by the user during a prolonged absence such as vacation. The system will perform a brief backwash and rinse based on the advanced setting. The purpose is to keep the water fresh in the softener tank and plumbing system.
	Yes	
	No	

Figure 7. Level I Program Options

Level I User Programming Flow Chart

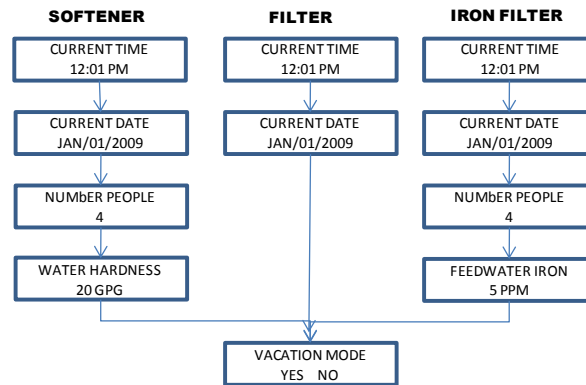

Figure 8. Level I User Program Flow Chart

Level II User Programming

When the Level Two Master Programming Mode is entered, all available option setting displays may be viewed and set as needed. Depending on current option settings, some parameters cannot be viewed or set.

1. Press “**MENU**” for three seconds to unlock screen.
2. Press and hold “**▲ ▼ UP AND DOWN**” for three seconds to enter Level Two Master Programming.

Level II Master Program Mode			
PARAMETER	OPTIONS	DESCRIPTION	
1	SYSTEM LANGUAGE	ENGLISH	This option controls which language should be used in the valve display.
		FRENCH	
		SPANISH	
2	VALVE OPERATION	SOFTENER	There are three basic operating modes to choose depending on the system application.
		FILTER	
		IRON FILTER	
3	REGEN. MODE	METER DELAYED	This is the most common setting. When the volume remaining reaches zero gallons, the system will initiate a regeneration at the next pre-set regeneration time.
		METER IMMEDIATE	The unit will initiate a regeneration immediately after the volume remaining reaches zero.
		CALENDAR CLOCK	The unit will initiate a regeneration at the next pre-set regeneration time based on the interval of days between regeneration days.
		METER OVERRIDE	When the volume remaining reaches zero gallons, the system will initiate a regeneration at the next pre-set regeneration time. If the days between regeneration is reached before the remaining volume reaches zero, the system will override the meter setting and initiate a regeneration.
4	REGENERATION TIME	This setting controls the time of day when a regeneration cycle will start.	
5	CAPACITY CALC.	AUTOMATIC	This option automatically calculates the capacity (in gallons for meter units), refill time (in minutes), or regeneration day intervals (days for calendar clock mode).
		MANUAL	The user can manually enter values for capacity, refill time, or regeneration day intervals.
6	RESIN VOLUME	This value should be the amount of resin in cubic feet that is loaded in to the tank. The value is used to calculate the system capacity and refill time.	
7	SALT SETTING	This value is the salt dosage (pounds per cubic foot) to be used when regenerating the system.	
8	REFILL FLOW RATE	This value is the flow rate (gallons per minute) of the brine line flow control (BLFC) button installed in the valve and is used to calculate the refill time to precisely measure the amount of water into the brine tank. (Note: This value is factory preset and should not be changed unless the BLFC button has been changed to a different size.)	
9	UNIT CAPACITY	This value (GRAINS for softeners, PPM for IRON FILTERS) is the total capacity of the system. It is used to calculate the capacity of the system in gallons.	
10	CAPACITY		In MANUAL CAPACITY CALC. mode, the CAPACITY can be adjusted by the user. In AUTOMATIC CAPACITY CALC. mode, the current calculated value is displayed but cannot be adjusted.
		FORMULA	$CAPACITY = (UNIT\ CAPACITY / WATER\ HARDNESS) - (NUMBER\ PEOPLE * DAILY\ USAGE)$
11	DAILY USAGE	This value is the average amount of water used per person per day. It is used to calculate the REGEN. DAYS for calendar clocks.	
12	RESERVE CAPACITY	This value is the amount of water per person in gallons to be saved for a reserve capacity. It is used to calculate the CAPACITY of the system.	
13	REGEN. DAYS		This value is the interval (days) between regenerations. It is used to determine how many days between regenerations in the CALENDAR CLOCK mode. It is also used as the value for the METER OVERRIDE mode. It can be set by the user in MANUAL CALC. MODE. In AUTOMATIC CAPACITY CALC. mode, the current calculated value is displayed but cannot be adjusted.
		FORMULA	$REGEN.\ DAYS = ((UNIT\ CAPACITY / WATER\ HARDNESS) / (NUMBER\ PEOPLE * DAILY\ USAGE)) - 1$
14	BACKWASH	This option controls the length of time in minutes for the unit to clean the bed by reversing the flow of water upwards through the bed and out to the drain.	
15	BRINE / RINSE	This option controls the length if time in minutes for the unit to draw regenerant (brine for softeners) from the second tank and slowly rinse it from the top to bottom of the tank.	
16	RINSE	This option controls the length of time to give the tank a final rinse from the top to the bottom in order remove any last traces of the regenerant (brine) from the tank.	
17	REFILL		This option controls the length of time the brine valve will open to refill the second tank (brine tank for softeners) with water in order to produce the regenerate solution (brine for softeners) for the next regeneration cycle. The water is accurately measured through the valves brine line flow control to make a precise quantity of regenerant solution. In MANUAL CAPACITY CALC. mode, the REFILL time can be adjusted by the user. In AUTOMATIC CAPACITY CALC. mode, the current calculated value is displayed but cannot be adjusted.
		FORMULA	$REFILL = SALT\ SETTING * RESIN\ VOLUME / 3 / REFILL\ FLOW\ RATE$
18	RESTORE DEFAULT	YES	This option allows the current settings to be erased and changed back to the default settings.
		NO	

Figure 9. Level II Program Options

Level II User Programming Softener Flow Chart

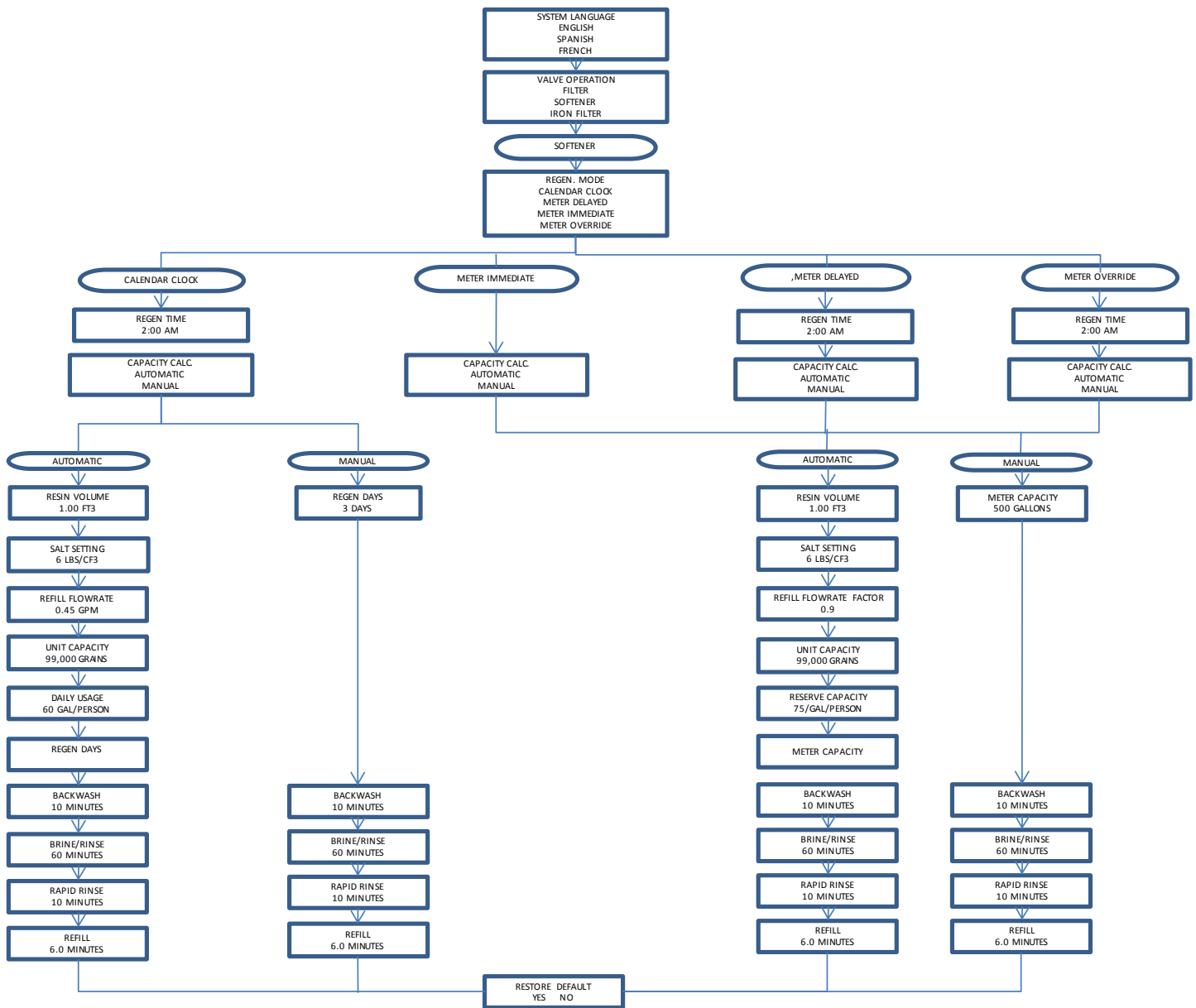

Figure 10. Level II User Program Flow Chart

Diagnostics Mode

1. Press “**□** MENU” for three seconds to unlock screen.
2. Press and hold the “**▲** AND **▼**” UP AND DOWN buttons for three seconds to enter Level Diagnostics Mode. In this mode, key diagnostics can be viewed for trouble shooting and problem solving. In addition, the values can be reset to zero individually by pressing “**♻** SET/REGEN” for 3 seconds

Vacation Settings Mode

1. Press “**□** MENU” for three seconds to unlock screen.
2. Press and hold the “**▼** DOWN” for three seconds to enter the Vacation Settings Mode. In this mode the length of time for backwash and rinse along with the frequency are set while the valve is in vacation mode.

PARAMETER	DESCRIPTION
REGEN. DAYS	This value is the frequency of how often the unit should perform a brief backwash and rinse.
BACKWASH	This option controls the length of time in minutes for the unit to briefly clean the bed by reversing the flow of water upwards through the bed and out to the drain.
RINSE	This option controls the length of time to give the tank a brief rinse from the top to the bottom in order to remove any stale or stagnant water from the tank.

Figure 11. Vacation Mode Settings















System Configuration

Valve Set Up

MODEL	VALVE CYCLE SETTINGS (MINUTES)						INJECTOR SIZE	DRAIN LINE FLOW CONTROL (GPM)	BRINE LINE FLOW CONTROL (GPM)
	CLEAN WATER			PROBLEM WATER					
	BACKWASH	BRINE/RINSE	RINSE	BACKWASH	BRINE/RINSE	RINSE			
NVO465-75	5.0	50.0	5.0	10.0	50.0	5.0	#00	#1 (1.5)	0.70
NVO465-100	5.0	50.0	5.0	10.0	50.0	5.0	#0	#2 (2.0)	0.70
NVO465-150	5.0	50.0	5.0	10.0	50.0	5.0	#1	#3 (2.4)	0.70
NVO465-200	5.0	50.0	5.0	10.0	50.0	5.0	#2	#4 (3.5)	0.70
NVO465-300	5.0	50.0	5.0	10.0	50.0	5.0	#3	#7 (5.0)	0.70
NVO465-75C	5.0	50.0	5.0	10.0	50.0	5.0	#00	#2 (2.0)	0.70
NVO465-100C	5.0	50.0	5.0	10.0	50.0 <td 5.0	#0	#3 (2.4)	0.70	

Figure 12. Valve Set Up

Changing Valve Cycle Settings

1. Press “ MENU” for three seconds to unlock screen.
2. Press and hold “  UP AND DOWN” for three seconds to enter Level Two Master Programming.
3. Press the “ DOWN” and advance to the BACKWASH menu option. Press “ SET/REGEN” to edit the BACKWASH minutes. Press “ or  UP OR DOWN” arrows to change the BACKWASH minute values. Press “ SET/REGEN” again to accept the new value.
4. Press the “ DOWN” twice to advance to the RINSE menu option. Press “ SET/REGEN” to edit the RINSE minutes. Press “ or  UP OR DOWN” arrows to change the RINSE minute values. Press “ SET/REGEN” again to accept the new value.
5. Press “ MENU” to exit programming mode.

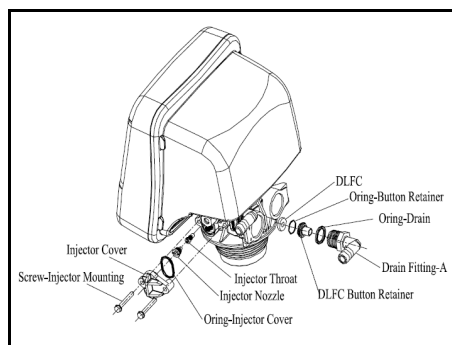

Figure 13. Valve Configuration View

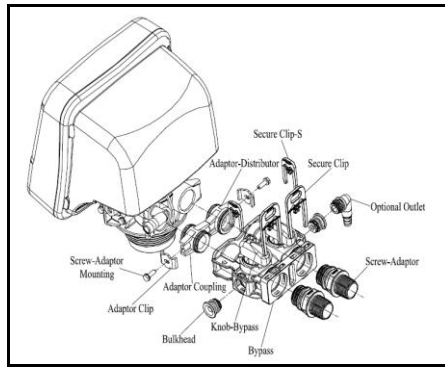

Figure 14. Bypass Installation View

Automatic Bypass

The regeneration cycle lasts approximately 70 minutes, after which soft water service will be restored. During regeneration, hard water is automatically bypassed for use in the household. Hot water should be used as little as possible during this time to prevent hard water from filling the water heater. This is why automatic regeneration is set for sometime during the night and manual regenerations should be performed when little or no water will be used in the household.

Safety Float

The brine tank is equipped with a safety float which prevents your brine tank from overflowing as a result of a malfunction such as a power failure.

New Sounds

You may notice new sounds as your water softener operates. The regeneration cycle lasts approximately 2 hours. During this time, you may hear water running intermittently to the drain.

Manual Bypass

In the case of emergency, such as an overflowing brine tank, you can isolate your water softener from the water supply using the bypass valve located at the back of the control. In normal operation the bypass is open with the on/off knobs in line with the inlet and outlet pipes. To isolate the softener, simply rotate the knobs clockwise (as indicated by the word BYPASS and arrow) until they lock. You can use your water related fixtures and appliances as the water supply is bypassing the softener. However, the water you use will be hard. To resume soft water service, open bypass valve by rotating the knobs counterclockwise.

Maintenance

Adding Salt

Use only crystal water softener salt. Check the salt level monthly. It is important to maintain the salt level above the water level. To add salt, simply lift the salt lid and add the salt directly into the brine tank. Be sure the brine well cover is on and fill only to the height of the brine well.

Bridging

Humidity or wrong type of salt may create a cavity between the water and the salt. This action, known as “bridging”, prevents the brine solution from being made, leading to your water supply being hard.

If you suspect salt bridging, carefully pound on the outside of the brine tank or pour some warm water over the salt to break up the bridge. This should always be followed up by allowing the unit to use up any remaining salt and then thoroughly cleaning out the brine tank. Allow four hours to produce a brine solution, then manually regenerate the softener.

Care of Your Softener

To retain the attractive appearance of your new water softener, clean occasionally with mild soap solution. Do not use abrasive cleaners, ammonia or solvents. Never subject your softener to freezing or to temperatures above 120°F.

Cleaning the Injector Assembly

Sediment, salt and silt will restrict or clog the injector. A clean water supply and pure salt will prevent this from happening.

The injector assembly is located on the right side of the control valve. This assembly is easy to clean.

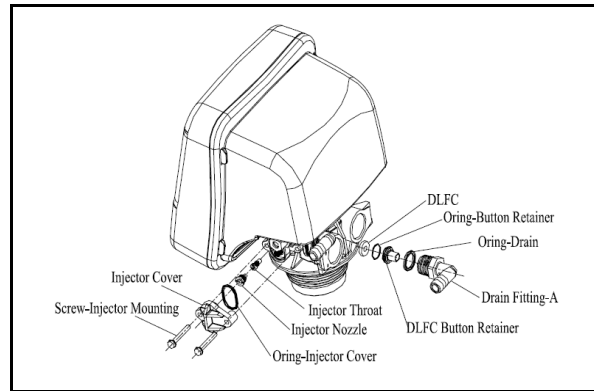

Figure 15. Injector Assembly View

Shut off the water supply to your softener and reduce the pressure by opening a cold soft water faucet. Using a screwdriver, remove the two screws holding the injector cover to the control valve body. Carefully remove the assembly and disassemble as shown in Figure 6. The injector orifice is removed from the valve body by carefully turning it out with a large screwdriver. Remove the injector throat the same way. Carefully flush all parts including the screen. Use a mild acid such as vinegar or Pro-Rust Out to clean the small holes in the orifice and throat.

Reassemble using the reverse procedure.

Resin Cleaner

An approved resin cleaner **must** be used on a regular basis if your water supply contains iron. The amount of resin cleaner and frequency of use is determined by the quantity of iron in your water (consult your local representative or follow the directions on the resin package).

Valve Drive Assembly Exploded View

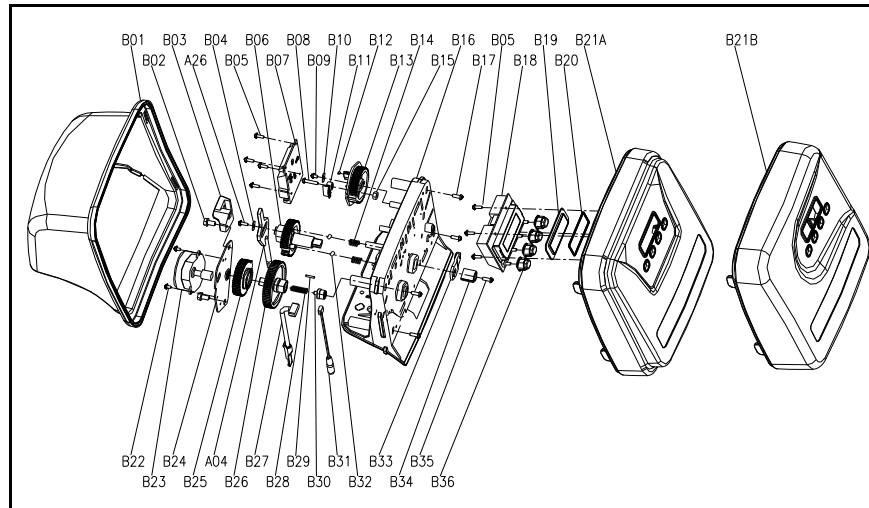

Item No.	Part No.	Part Description	Quantity
B01	05056523	BNT365 Cover	1
B02	05056136	Screw -ST3.5x13 (Hexagon with Washer)	2
B03	05010045	Piston Stem Holder	1
A26	13000426	Screw -ST2.9x13 (Large Washer)	1
B04	05056139	Washer-3x13	1
B05	05010037	Screw -ST2.9x10	8
B06	05056005	Main Gear	1
B07	05030010	Bnt85 Main Pcb	1
B08	05056083	Screw -M 4x14	1
B09	05056166	Screw -ST4.2x12 (Large Washer)	1
B10	05056141	Washer-4x12	1
B11	05056016	Brine Regulator	1
B12	05010023	Magnet-48x2.7	1
B13	05056015	Brine Gear	1
B14	05056095	Spring Detent	2
B15	05056089	Nut-M 4	1
B16	05056522	Bnt865 Housing	1
B17	05056084	Screw -ST3.5x13	4
B18	05030020	Bnt85-Display (NOVO)	1
B19	05056528	Pcb Cover	1
B20	26010047	O-Ring-4x2.5x1.8	1
B21	05056527	Bnt865 Front Cover	1
B22	05056082	Screw -M 3x6	2
B23	05056510	Motor-12v/2rpm	1
	05030014	Motor Power Cable	1
	11700005	Wire Connector	2
B24	05056045	Motor Mounting Plate	1
B25	05056501	Drive Gear	1
A04	05010081	Bnt85 Piston Rod	1
B26	05056002	Idler Gear	1
B27	05010031	Meter Assembly	1
	05010046	Meter Strain Relief	1
B28	05056094	Spring Idler	1
B29	05056098	Motor Pin	1
B30	05056502	Spring Retainer	1
B31	05010029	Power Cable	1
	05056013	Power Strain Relief	1
B32	05056092	Ball-1/4inch	2
B33	05056503	Magnet Holder	1
B34	05056554	Locking Knob	1
B35	05056561	Screw -ST3.5x5 (CSK)	1
B36	05056529	Bnt865 Button	4

Trouble Shooting

Issue	Possible Cause	Possible Solution
A. Unit fails to initiate a regeneration cycle.	1. No power supply.	Check electrical service, fuse, etc.
	2. Defective circuit board.	Replace faulty parts.
	3. Power failure.	Reset time of day.
B. Water is hard.	1. By-pass valve open.	Close by-pass valve.
	2. Out of salt.	Add salt to tank.
	3. Plugged injector / screen.	Clean parts.
	4. Flow of water blocked to brine tank.	Check brine tank refill rate.
	5. Hard water in hot water tank.	Repeat flushing of hot water tank required.
	6. Leak between valve and central tube.	Check if central tube is cracked or o-ring is damaged. Replace faulty parts.
	7. Internal valve leak.	Replace valve seals, spacer, and piston assembly.
C. Salt use is high.	1. Refill time is too high.	Check refill time setting.
D. Low water pressure.	1. Iron or scale build up in line feeding unit.	Clean pipes.
	2. Iron build up inside valve or tank.	Clean control and add resin cleaner to clean bed. Increase regeneration frequency.
	3. Inlet of control plugged due to foreign material.	Remove piston and clean control valve.
E. Resin in drain line.	1. Air in water system.	Check well system for proper air eliminator control.
	2. Incorrect drain line flow control (DLFC) button.	Check for proper flow rate.
F. Too much water in brine tank.	1. Plugged injector or screen.	Clean parts.
	2. Valve not regenerating.	Replace circuit board, motor, or control.
	3. Foreign material in brine valve.	Clean parts.
G. Unit fails to draw brine.	1. Drain line flow control is plugged.	Clean parts.
	2. Injector or screen is plugged.	Clean parts.
	3. Inlet pressure too low.	Increase pressure to 25 PSI.
	4. Internal valve leak.	Replace seals, spacers, and piston assembly.
H. Valve continuously cycles.	1. Defective position sensor PCB.	Replace faulty parts.
I. Flow to drain continuously.	1. Valve settings incorrect.	Check valve settings.
	2. Foreign material in control valve.	Clean control.
	3. Internal leak.	Replace seals, spacers, and piston assembly.

NovoSoft Guarantee

Novo Water Conditioning Products guarantees that your new water conditioner is built of quality material and workmanship. When properly installed and maintained, it will give years of trouble free service.

Seven Year Complete Parts Guarantee

Novo Water Conditioning Products will replace any part which fails within 84 months from date of manufacture, as indicated by the serial number, provided the failure is due to a defect in material or workmanship. The only exception shall be when proof of purchase or installation is provided and then the warranty period shall be from the date thereof.

Life Time Year Guarantee on Mineral Tanks and Brine Tanks

Novo Water Conditioning Products will provide a replacement mineral tank or brine tank to any original equipment purchaser in possession of a tank that fails provided that the water conditioner is at all times operated in accordance with specifications and not subject to freezing.

General Provisions

Novo Water Conditioning Products assumes no responsibility for consequential damage, labour or expense incurred as a result of a defect or for failure to meet the terms of these guarantees because of circumstances beyond its control.

